

# MACARON LAMP by Silvia Ceñal

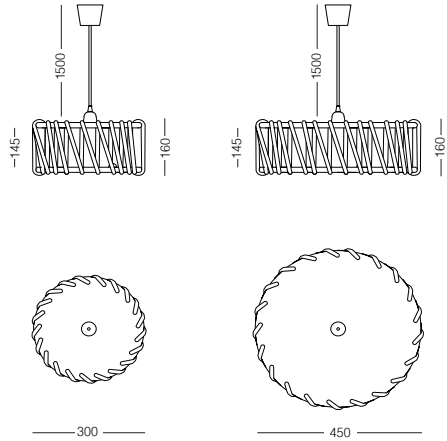

Pendant

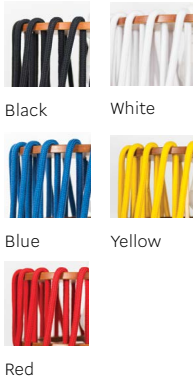

Floor

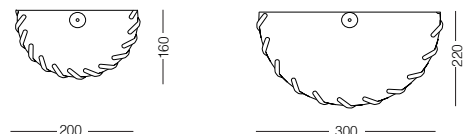
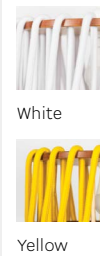
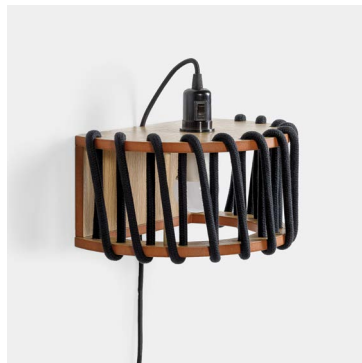
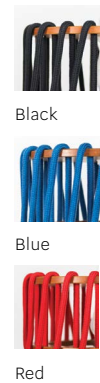
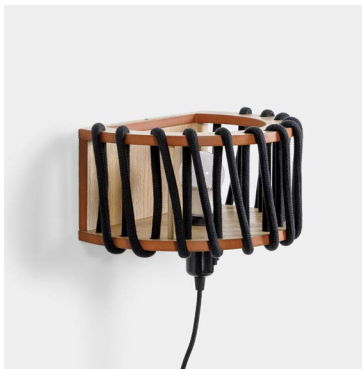
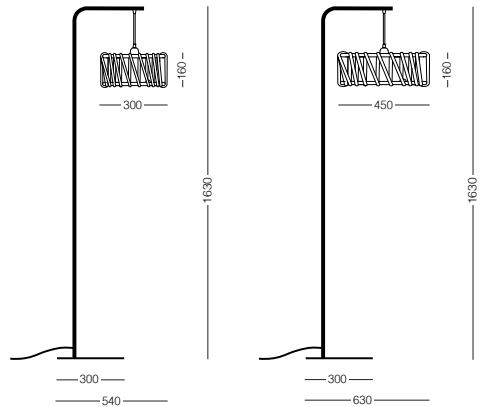
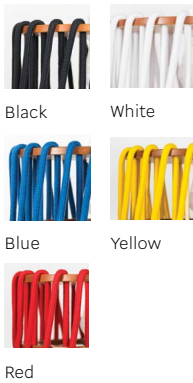

Wall

**Materials** veneered MDF, rope, painted iron frame